















SEZNAM DÍLŮ
PART LIST

	IMBUS ALLAN KEY	1x		KOLÍK DOWELL	16x
	LIŠTA STRIP	1x		KONFIRMÁT CONFIRMAT	12x
	KOVÁNÍ NA DVEŘE DOOR HARDWARE	6x		POLICOVÝ KOLÍK SHELF SUPPORT	12x
	ÚCHYTKA PULL	3x		KRYTKA SCREW COVER	12x
	VODICÍ LIŠTA PLASTIC STRIP	4x		HŘEBÍKY NAILS	50x
	DRŽÁK ŠATNÍ TYČE ROD SOCKET	2x		VRUTY KOVÁNÍ SCREW HARDWARE	24x
	ŠATNÍ TYČ ROD	1x		VRUTY ÚCHYTKY SCREW PULL	6x



3

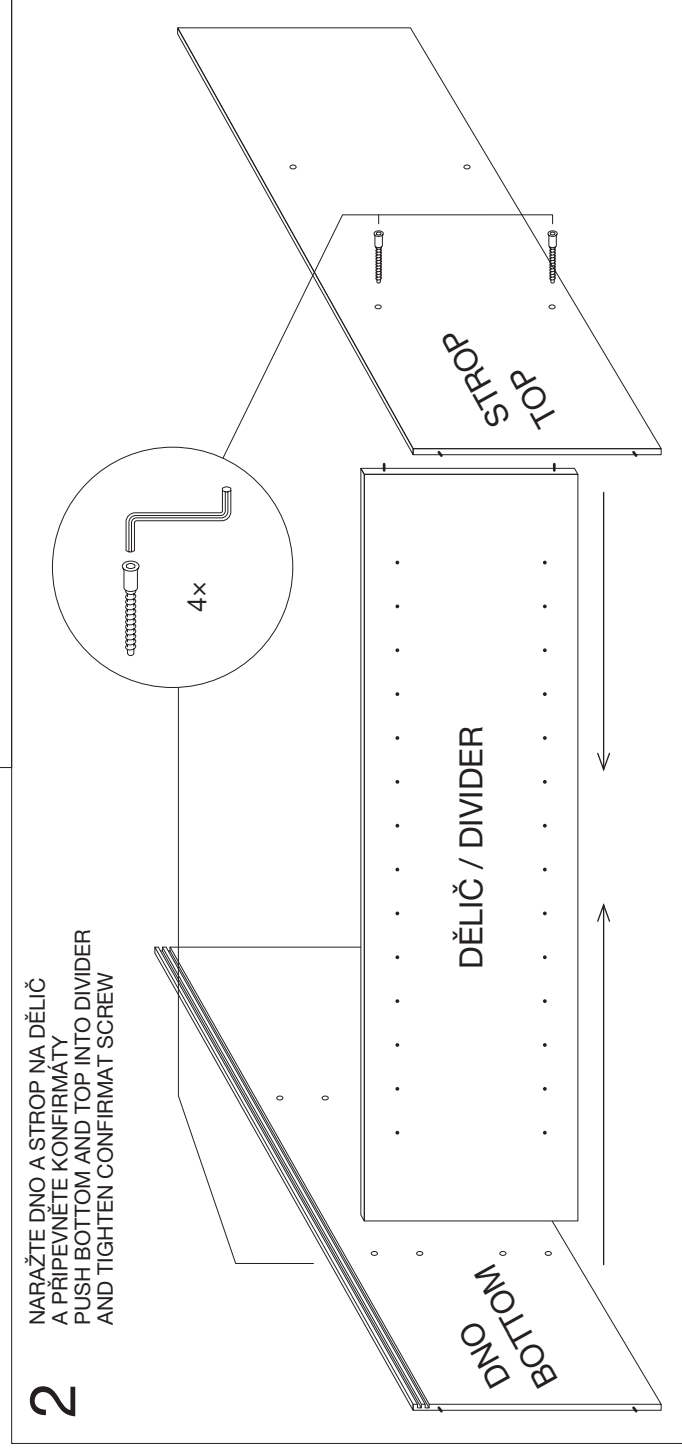
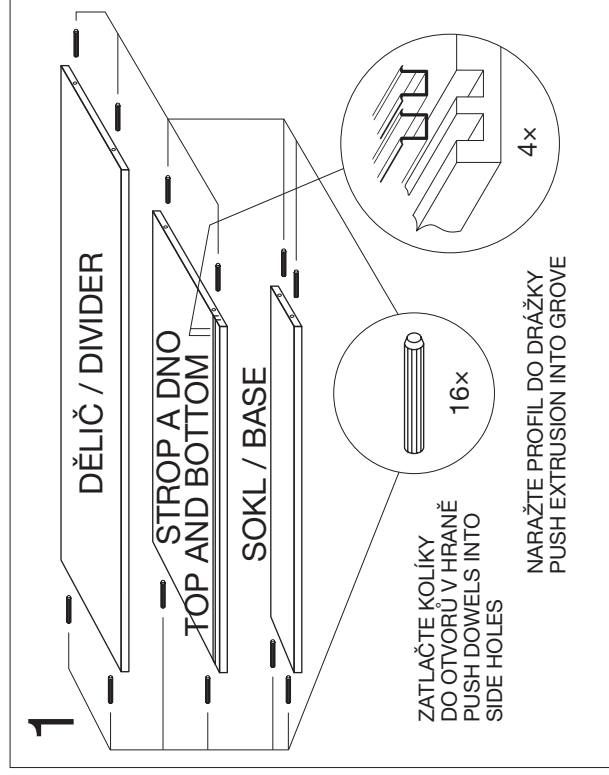
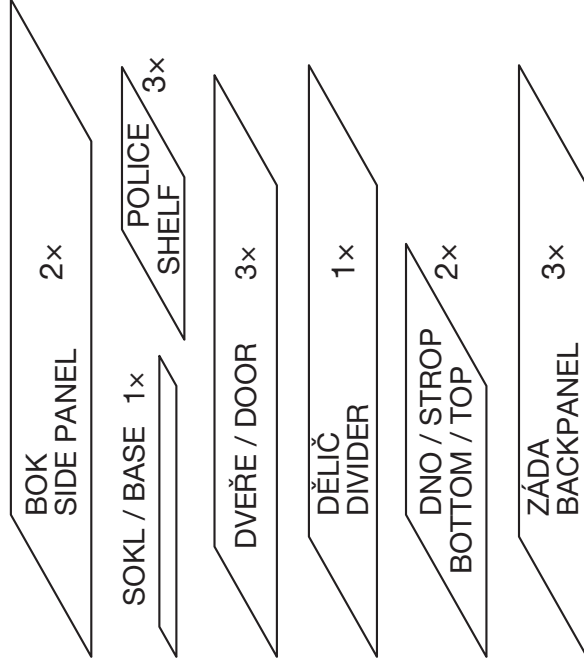
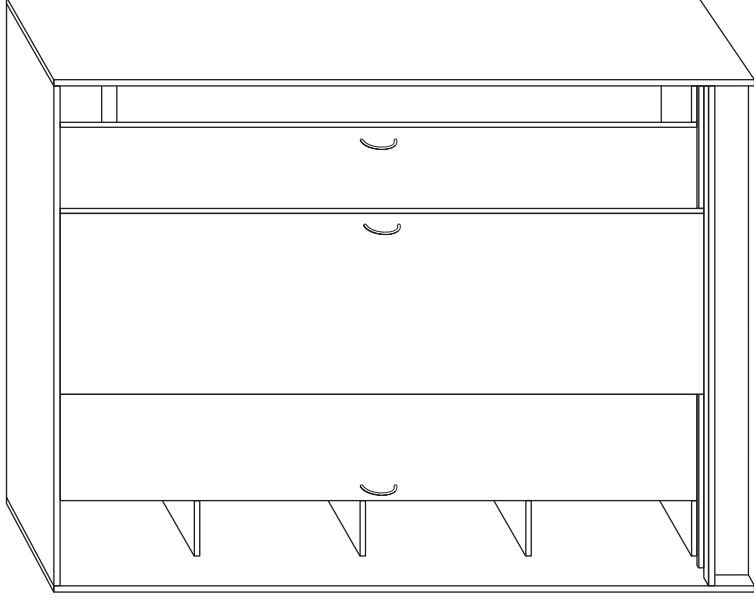
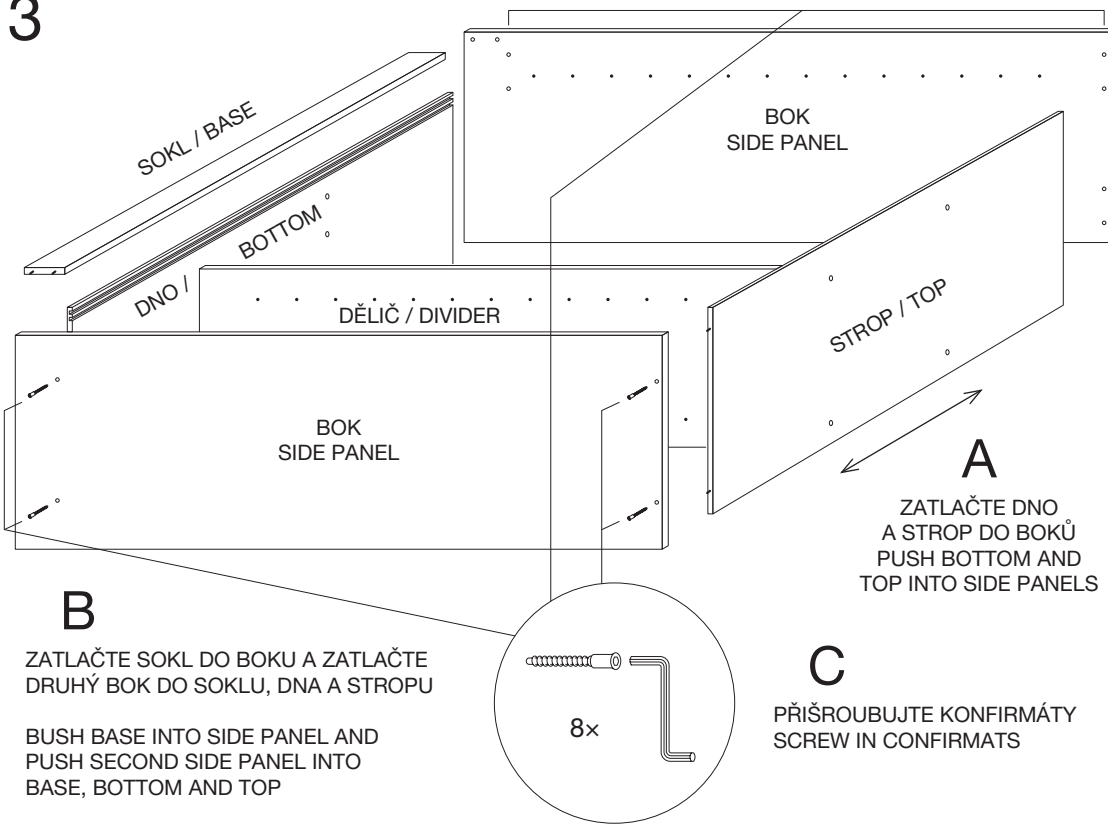

B
ZATLAČTE SOKL DO BOKU A ZATLAČTE DRUHÝ BOK DO SOKLU, DŇA A STROPU
BUSH BASE INTO SIDE PANEL AND PUSH SECOND SIDE PANEL INTO BASE, BOTTOM AND TOP

C
PŘIŠROBUJTE KONFIRMÁTY SCREW IN CONFIRMATS

A
ZATLAČTE DNO A STROP DO BOKŮ PUSH BOTTOM AND TOP INTO SIDE PANELS

5

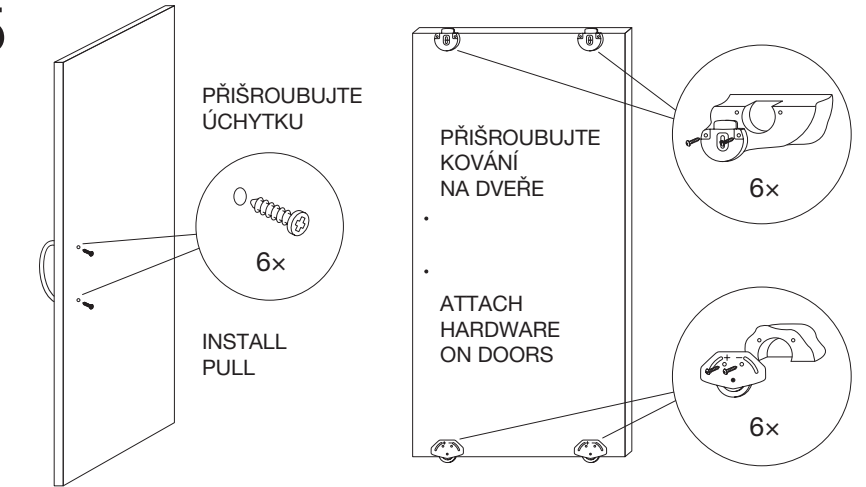

PŘIŠROBUJTE ÚCHYTKU

INSTALL PULL

PŘIŠROBUJTE KOVÁNÍ NA DVEŘE

ATTACH HARDWARE ON DOORS

6x

6x

6

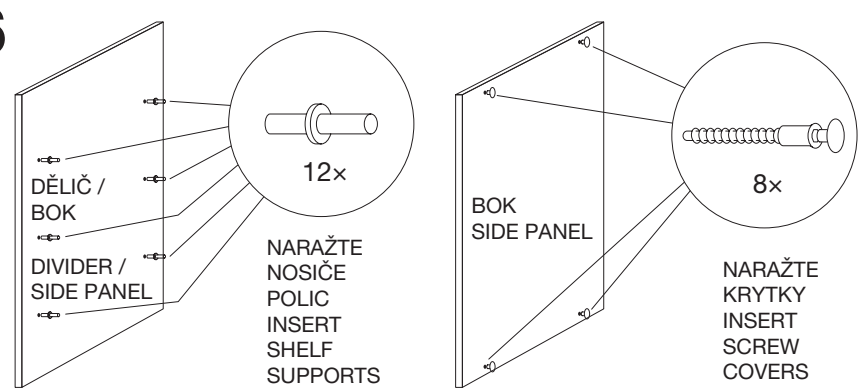

DĚLIČ / BOK
DIVIDER / SIDE PANEL

12x

NARAŽTE NOSIČE POLIC INSERT SHELF SUPPORTS

BOK SIDE PANEL

8x

NARAŽTE KRYTKY INSERT SCREW COVERS

4

B

PŘIBIJTE ZÁDA NA NEOLEPENÉ HRANY NAIL BACKPANEL TO NONEDGEBAND EDGES

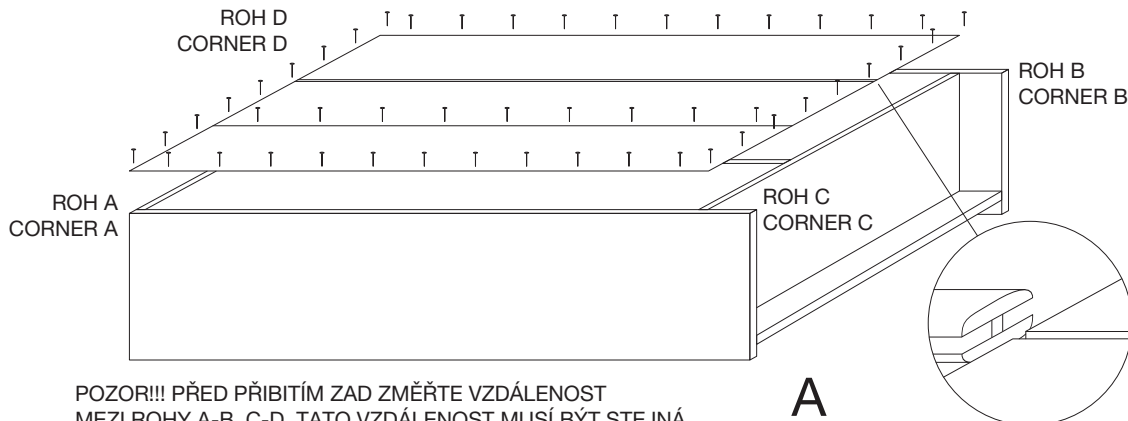

POZOR!!! PŘED PŘIBITÍM ZAD ZMĚŘTE VZDÁLENOST MEZI ROHY A-B, C-D. TATO VZDÁLENOST MUSÍ BÝT STEJNÁ. ATTENTION!!! BEFORE NAILING BACKPANEL MEASURE THE DISTANCE A-B, C-D. THIS DISTANCE MUST BE THE SAME.

A

NASUŇTE ZÁDA DO LIŠTY INSERT BACKPANEL INTO STRIP

7

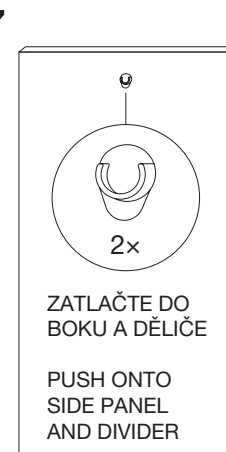

ZATLAČTE DO BOKU A DĚLIČE

PUSH ONTO SIDE PANEL AND DIVIDER

2x

8

NASTAVENÍ DVEŘÍ DOOR ADJUSTMENT

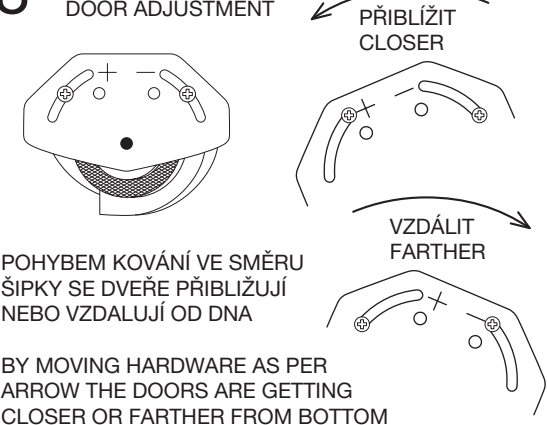

PŘIBLIŽIT CLOSER

VZDÁLIT FARTHER

POHYBEM KOVÁNÍ VE SMĚRU ŠIPKY SE DVEŘE PŘIBLIŽUJÍ NEBO VZDALUJÍ OD DŇA

BY MOVING HARDWARE AS PER ARROW THE DOORS ARE GETTING CLOSER OR FARTHER FROM BOTTOM