

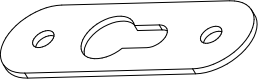

A		02
B	 3,5x14	04

01



02

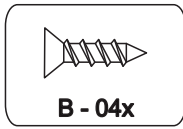
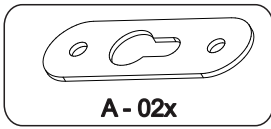
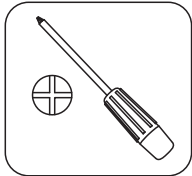
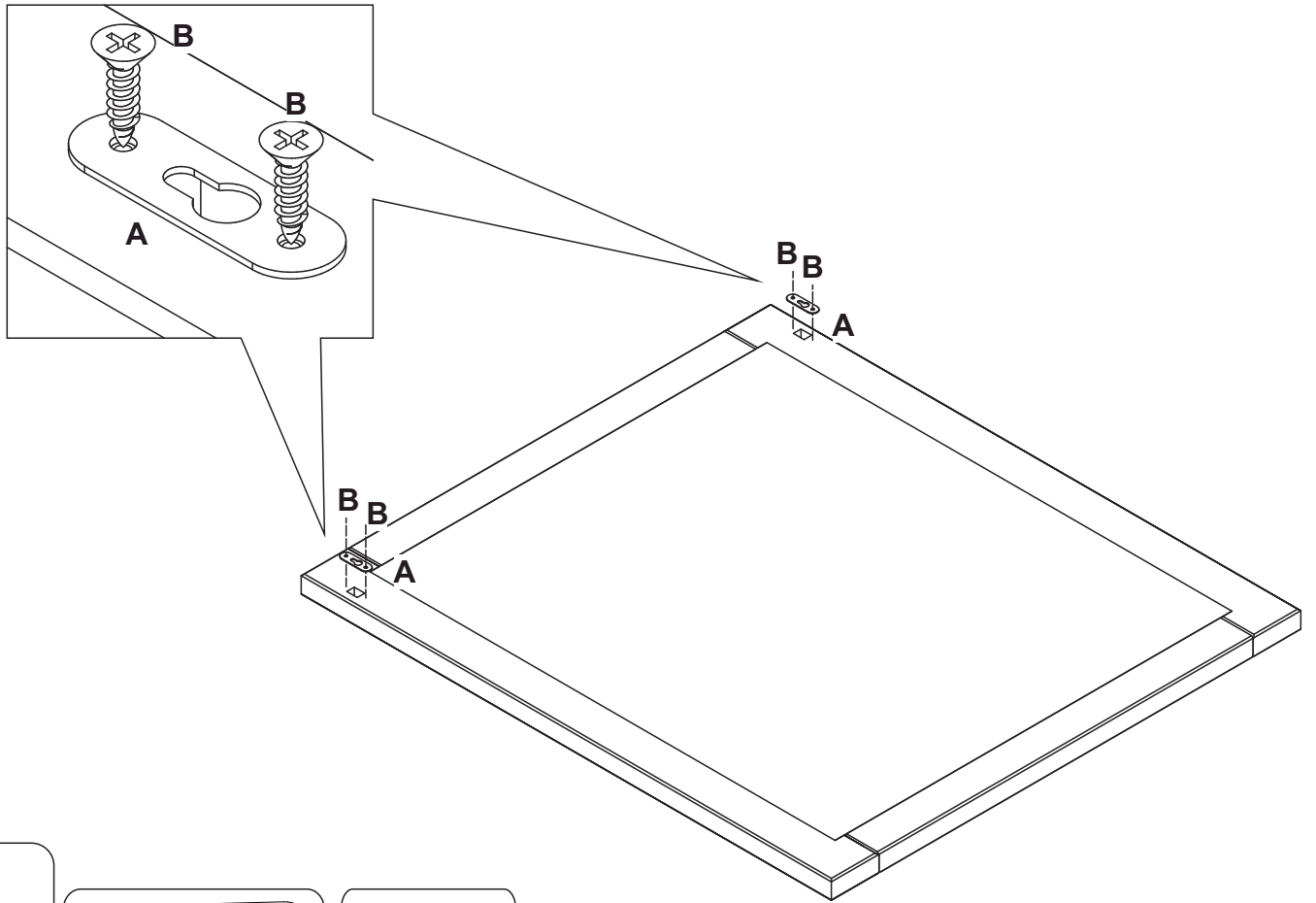
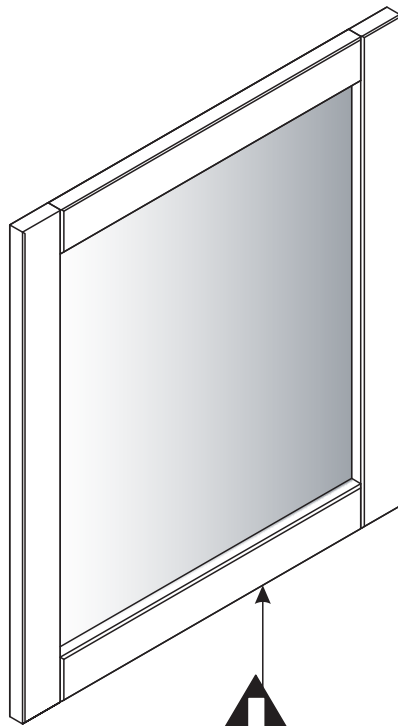

03

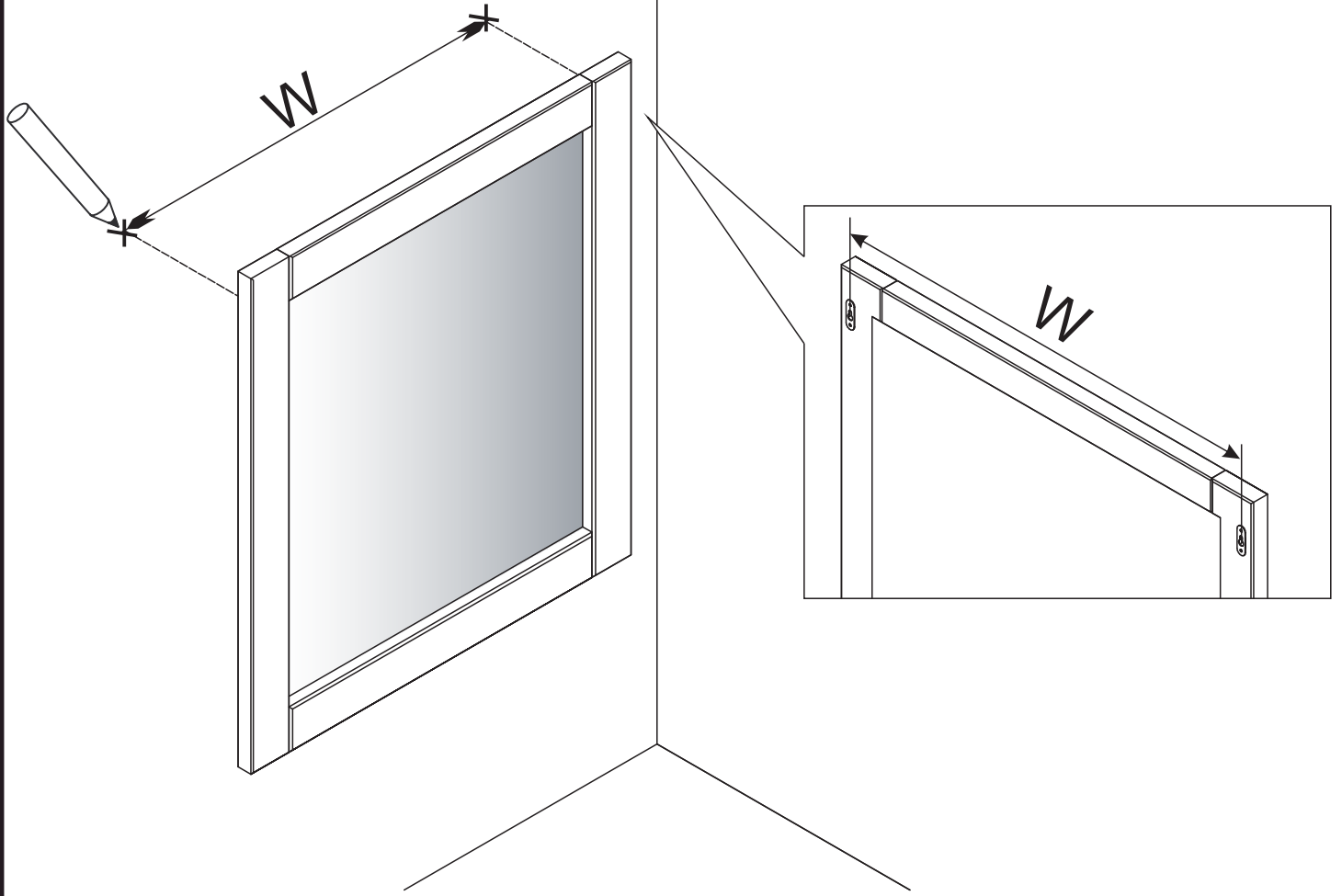

04

