

160204

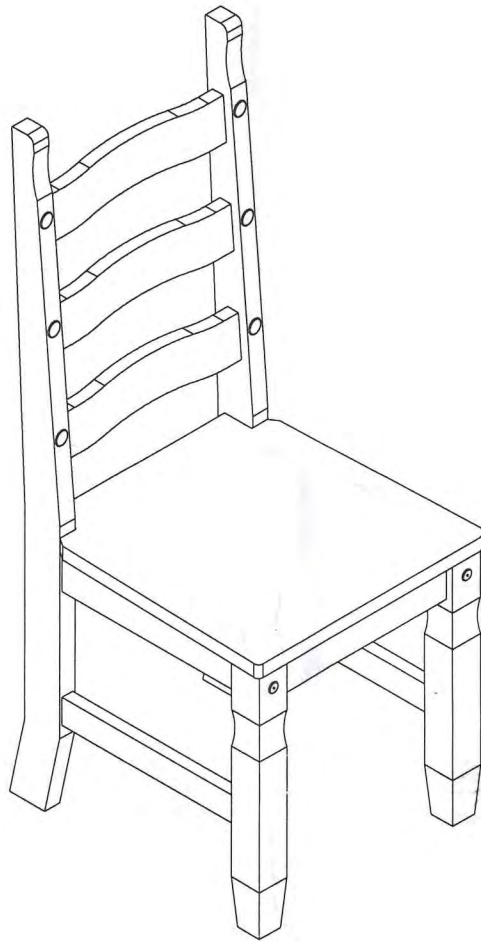

Ref.: 035

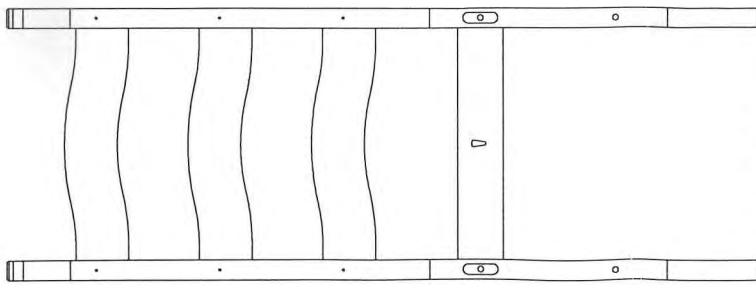

1 103 x 38,6cm (2x)

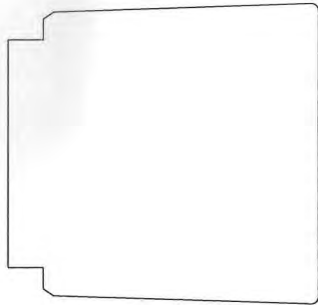

2 44 x 43cm (2x)

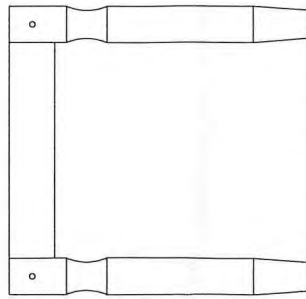



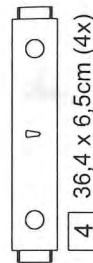

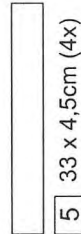

3 43 x 41,2cm (2x)









4 36,4 x 6,5cm (4x)

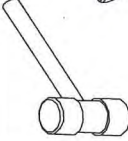

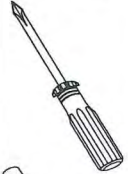

5 33 x 4,5cm (4x)

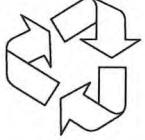
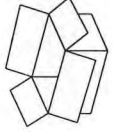
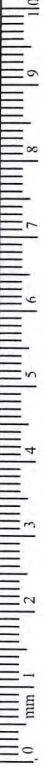
<p>A x 8</p>  <p>Ø8x30mm</p>	<p>Ex 8</p> 
<p>B x 8</p>  <p>Ø4,0x35mm</p>	<p>F x 1</p> 
<p>C x 8</p>  <p>Ø4,5x50mm</p>	<p>G x 12</p> 
<p>D x 8</p>  <p>Ø6,5x100mm</p>	

  		
	 <p>30 min</p>	 
		

1

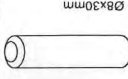
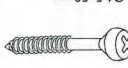
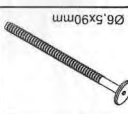
2x

Ax4	Cx4	Dx4	Ex4	Fx1
				
Ø8x30mm	Ø4,5x50mm	Ø6,5x90mm		

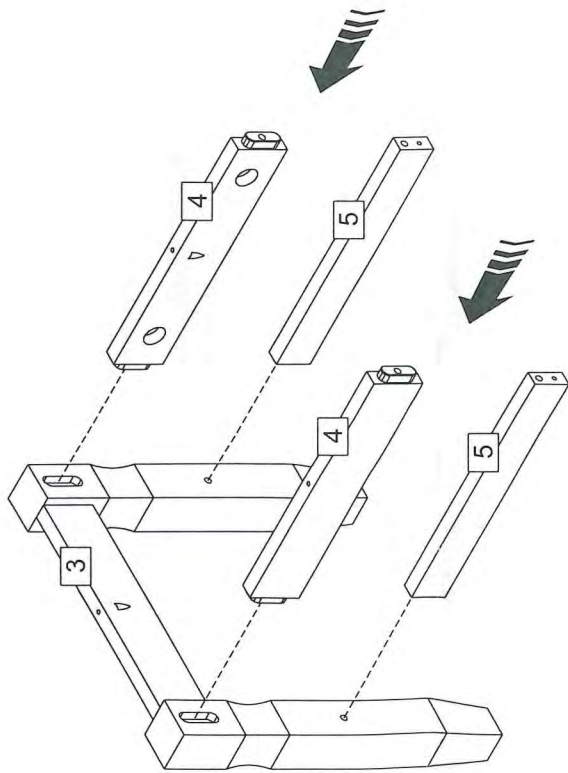

b:

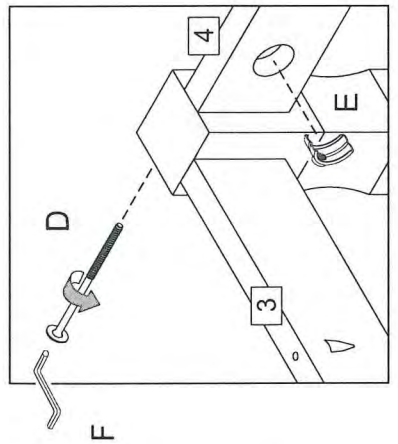

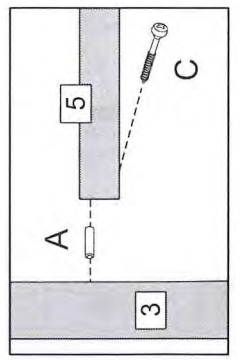

a:

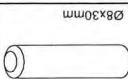
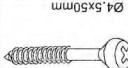
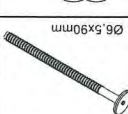

2

2x

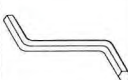
Ax4	Cx4	Dx4	Ex4	Fx1
				
Ø8x30mm	Ø4,5x50mm	Ø6,5x90mm		

a:

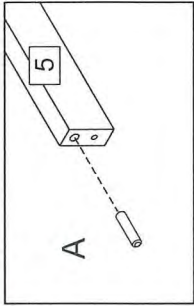

b:

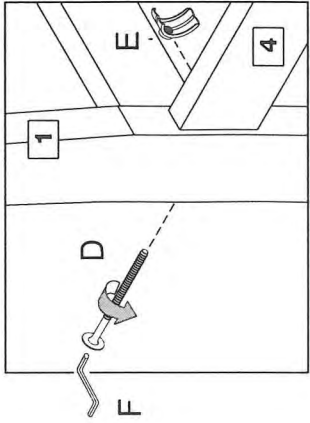

c:

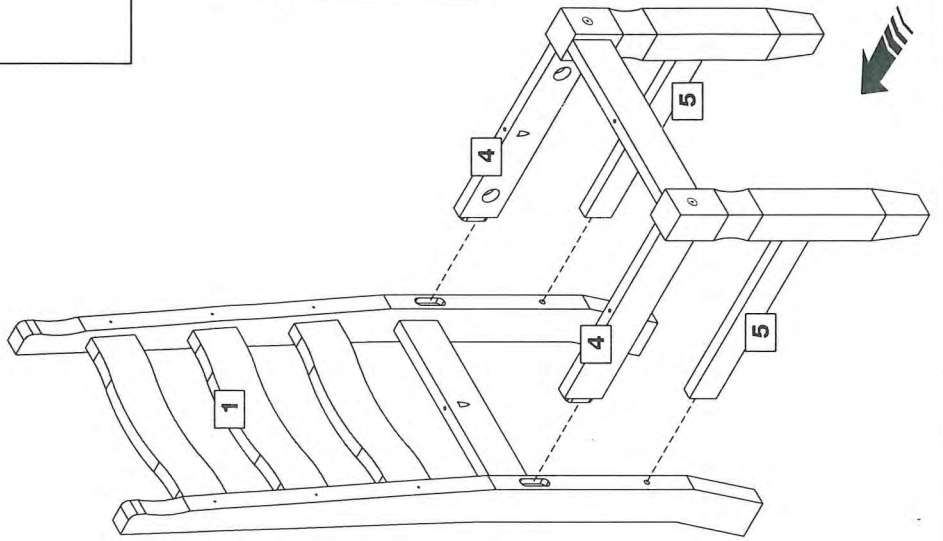
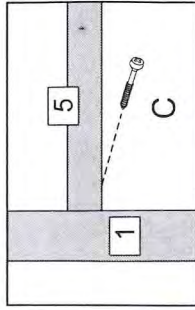

3

a:

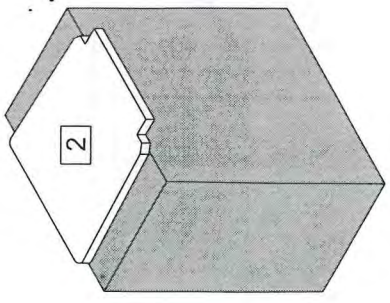

b:

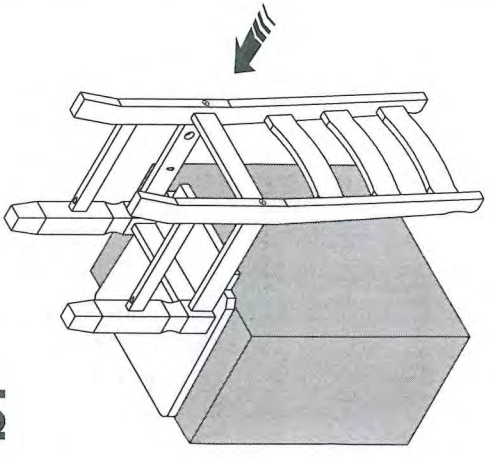

2x

5

2x

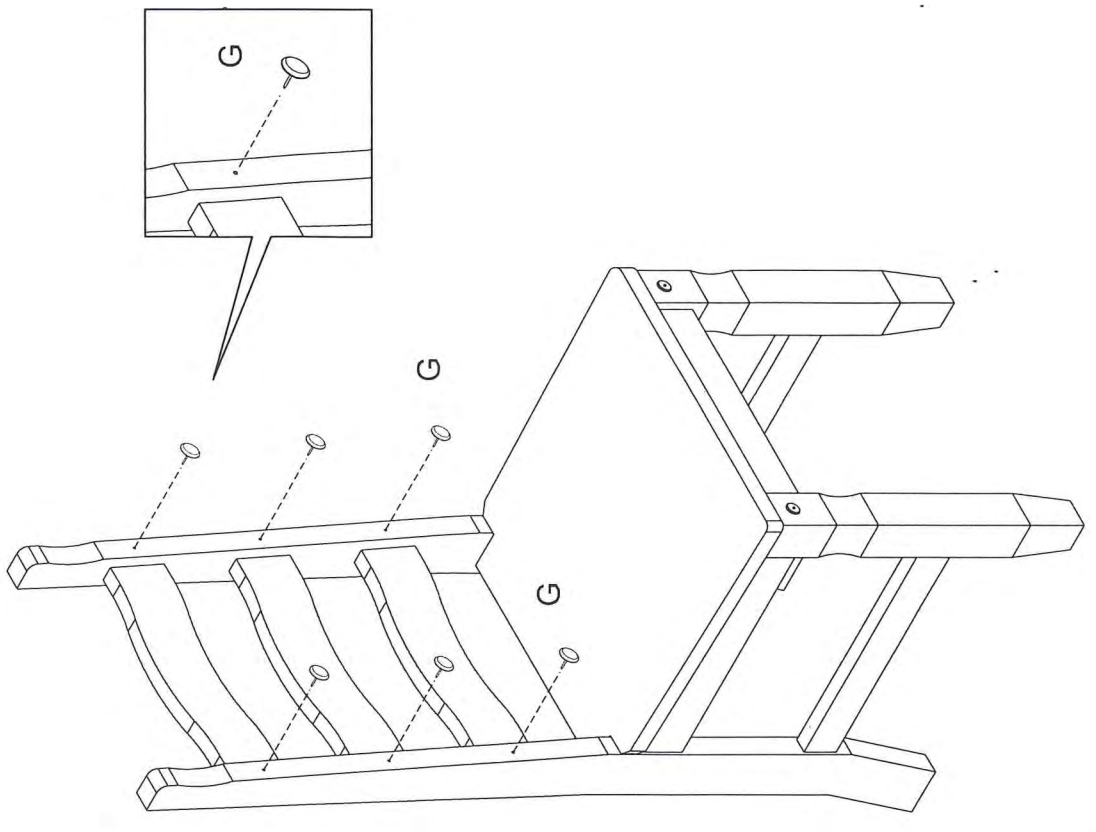
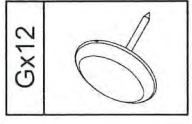

4

2x

